

Inline™ Manifolds Ordering Information

Mold Mounted Manifolds provide many benefits to the operation and performance of the water cooled process. Our manifolds offer a myriad of combinations to suit your needs.

STANDARD MANIFOLDS

1. Choose your manifold from the following pages.
2. Stock Manifolds will ship same day if order is received before 2 p.m. CT.

WHEN ORDERING CUSTOM MANIFOLDS

1. Submit design or sketch.
2. Cito will make CAD drawing and submit via fax with price quote and delivery information.
3. Upon approval of drawing, the manifold will be shipped the following monday.

TO ORDER YOUR DESIGN KIT FOR INLINE MANIFOLDS

Our Design Kit will assist in your mold or machine mounted design of Inline™ Manifolds — complete with CAD Patterns, and custom order forms.

Please contact our Sales Department

CITO PRODUCTS INC.

N8779 Hwy. X • P.O. Box 90

Watertown, WI 53094 • USA

Phone: (920) 261-2606

Fax: (920) 261-1350

E-mail: sales@pulsecooling.com

ATTENTION: SALES DEPARTMENT

Please specify which CAD system you are using when requesting your Design Kit.

The Design Kit is available in:

.PRT (CadKey)

.DWG (AutoCad)

.DXF (Data Exchange Format)

.IGES (International Graphic Exchange)

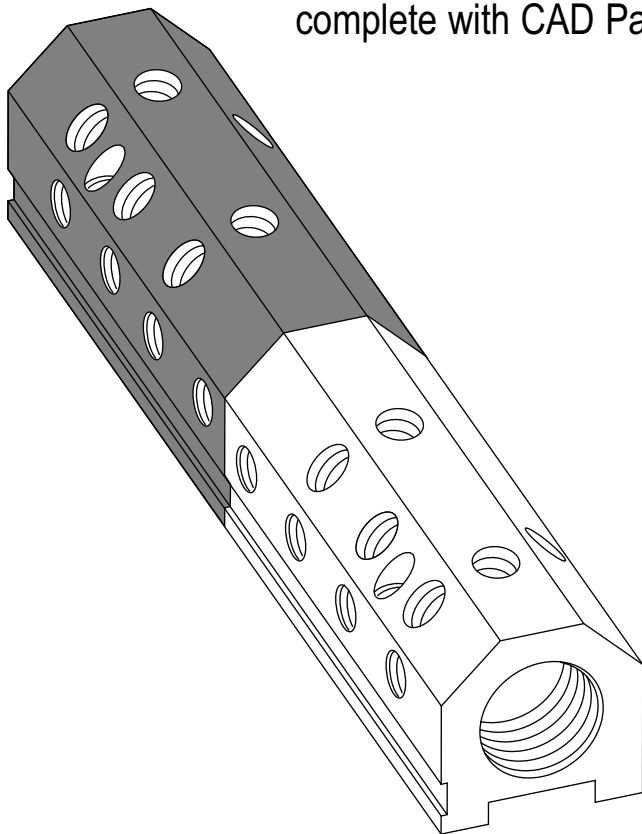

The anodized aluminum is not suitable for corrosive liquids (high chlorine content)

3/4" Inline™ Manifold

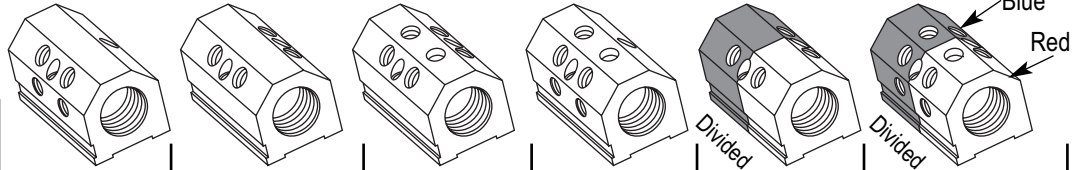
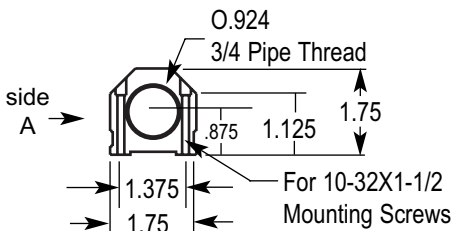
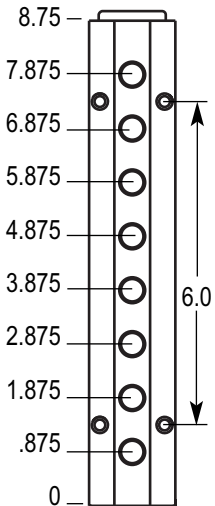
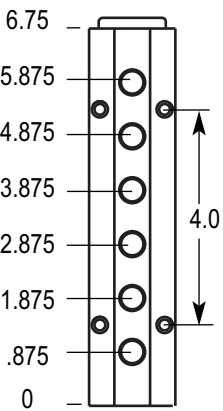
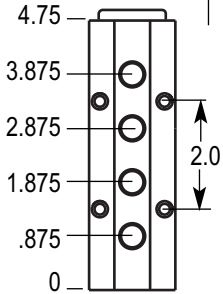
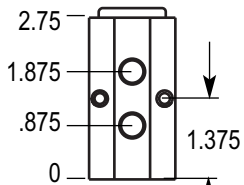

IM3-2-AB-4 1/8 or 1/4 \$43.00
 IM3-2-BD-4 1/8 or 1/4 \$43.00
 IM3-2-BCD-6 1/8 or 1/4 \$49.00
 IM3-2-ABC-6 1/8 or 1/4 \$49.00
 IM3-2-BD-2-2 1/8 or 1/4 \$59.00
 IM3-2-ABCDE-5-5 1/8 \$77.00

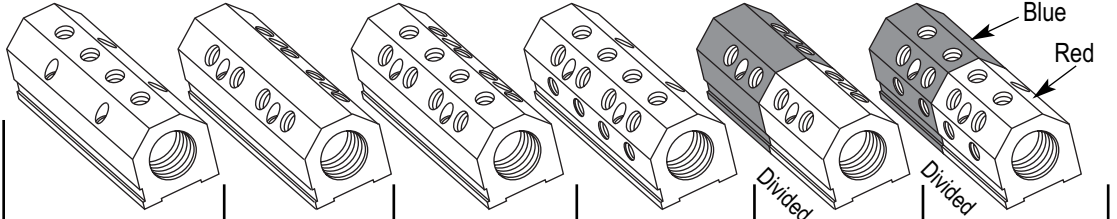

IM3-4-C-4 1/8 or 1/4 \$53.00
 IM3-4-BD-8 1/8 or 1/4 \$65.00
 IM3-4-BCD-12 1/8 or 1/4 \$77.00
 IM3-4-ABC-12 1/8 or 1/4 \$77.00
 IM3-4-BD-4-4 1/8 or 1/4 \$81.00
 IM3-4-ABC-6-6 1/8 or 1/4 \$93.00

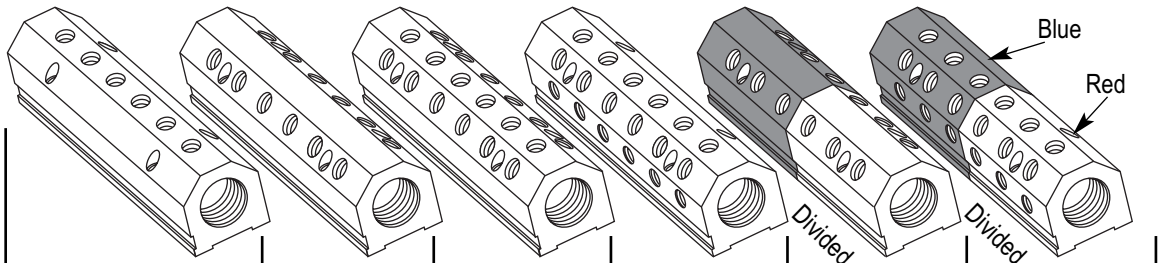

IM3-6-C-6 1/8 or 1/4 \$69.00
 IM3-6-BD-12 1/8 or 1/4 \$87.00
 IM3-6-BCD-18 1/8 or 1/4 \$105.00
 IM3-6-ABC-18 1/8 or 1/4 \$105.00
 IM3-6-BD-6-6 1/8 or 1/4 \$103.00
 IM3-6-ABC-9-9 1/8 or 1/4 \$121.00

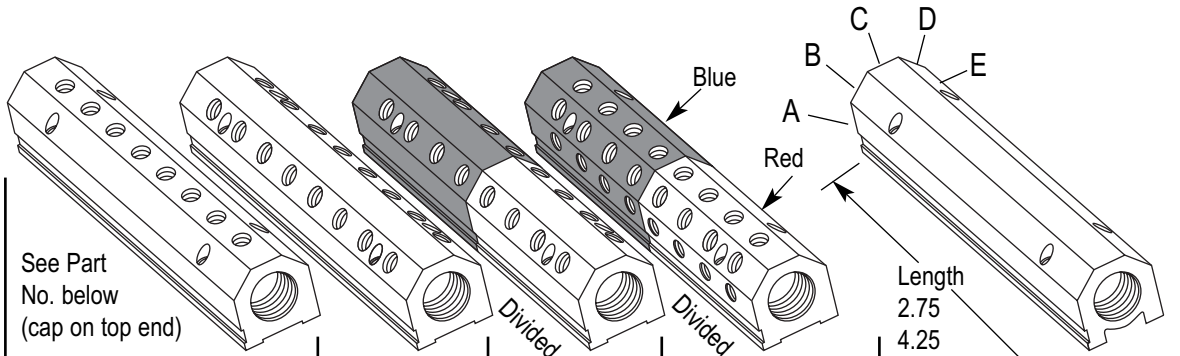

See Part No. below (cap on top end)

IM3-8-C-8 1/8 or 1/4 \$85.00
 IM3-8-BD-16 1/8 or 1/4 \$109.00
 IM3-8-BD-8-8 1/8 or 1/4 \$125.00
 IM3-8-ABC-12-12 1/8 \$149.00

PART NUMBER CODE:

IM3-6-B-6-1/4-N-BLUE

Red, Blue or Divided
 Thread Type: N=(NPT) No Mark
 P=Mark BSPP
 T=Mark BSPT
 6 Holes
 Row on side "B"
 6=6.750" Overall Length
 (3)=3/4" Port
 Inline Manifold

3/4" NPT

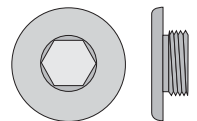

For Solid Color Manifolds
PRICES INCLUDE: End Cap and
 Stainless 10 - 32 x 1-1/2" SHCS.
 ADDITIONAL 3/4" MANIFOLD END
 CAPS: IM-8630 - \$5.80ea.
CUSTOM MANIFOLDS
QUOTED UPON REQUEST

The anodized aluminum is not suitable for corrosive liquids (high chlorine content)

1-1/2" Inline™ Manifold

Technical drawings on the left show manifold profiles with dimensions: 3.0, 4.0, 6.0, 8.0, 10.0, 12.0, 14.0, 16.0, 18.0. A detailed view of the 1-1/2" NPT port shows dimensions: 01.7434, 1-1/2 Thread, 1.5, 2.0, 3.0, 2.25, 3.0. Text: "For 1/4-20x2-1/2" Mounting Screws".

IM6-6-AB-4 3/8 or 1/2 \$83.00	IM6-6-BD-4 3/8 or 1/2 \$83.00	IM6-6-BCD-6 3/8 or 1/2 \$91.00	IM6-6-ABC-6 3/8 or 1/2 \$91.00	IM6-6-BD-2-2 3/8 or 1/2 \$103.00	IM6-6-ABCDE-5-5 3/8 or 1/2 \$127.00
IM6-10-C-4 3/8 or 1/2 \$111.00	IM6-10-BD-8 3/8 or 1/2 \$127.00	IM6-10-BCD-12 3/8 or 1/2 \$143.00	IM6-10-ABC-12 3/8 or 1/2 \$143.00	IM6-10-BD-4-4 3/8 or 1/2 \$147.00	IM6-10-ABC-6-6 3/8 or 1/2 \$163.00
IM6-14-C-6 3/8 or 1/2 \$147.00	IM6-14-BD-12 3/8 or 1/2 \$171.00	IM6-14-BCD-18 3/8 or 1/2 \$195.00	IM6-14-ABC-18 3/8 or 1/2 \$195.00	IM6-14-BD-6-6 3/8 or 1/2 \$191.00	IM6-14-ABC-9-9 3/8 or 1/2 \$215.00
IM6-18-C-8 3/8 or 1/2 \$183.00	IM6-18-BD-16 3/8 or 1/2 \$215.00	IM6-18-BD-8-8 3/8 or 1/2 \$235.00	IM6-18-ABC-12-12 3/8 or 1/2 \$267.00	See Part No. below (cap on top end)	

PART NUMBER CODE:
IM6-14-B-6-3/8-N-BLUE

- IM6 - Inline Manifold
- 14 - 14" Overall Length
- B - Row on side "B"
- 6 - 6 Holes
- 3/8 - 3/8" "Out"
- N - Thread Type: N=(NPT) No Mark, P=Mark BSPP, T=Mark BSPT
- BLUE - Red, Blue or Divided

Length: 6.0, 10.0, 14.0, or 18.0

1-1/2" NPT

For Solid Color Manifolds
PRICES INCLUDE: End Cap and Stainless 1/4" - 20 x 2-1/2" SHCS.
ADDITIONAL 1-1/2" MANIFOLD END CAPS: IM-8660 - \$14.00ea.
CUSTOM MANIFOLDS QUOTED UPON REQUEST

The anodized aluminum is not suitable for corrosive liquids (high chlorine content)

2" Inline™ Manifold

NOTE FOR ALL IM MANIFOLDS:

Catalogue part number as shown
Standard length and standard hole position part No. with -S
Any length and any hole configuration - SS

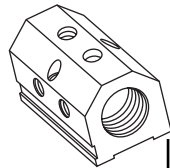
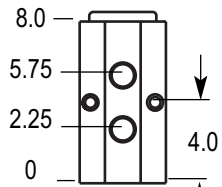

IM8-8-ACE-6
1/2, 3/4 or 1
\$134.00

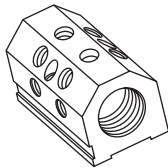

IM8-8-ABCDE-10
1/2 or 3/4
\$158.00

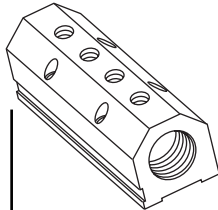
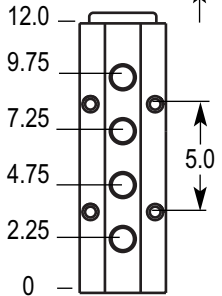

IM8-12-C-4
1/2, 3/4 or 1
\$154.00

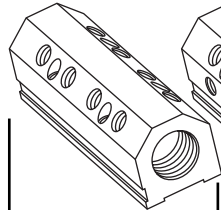

IM8-12-BD-8
1/2, 3/4 or 1
\$178.00

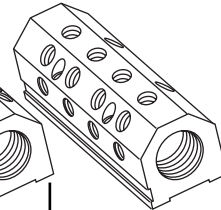

IM8-12-ABC-12
1/2 or 3/4
\$202.00

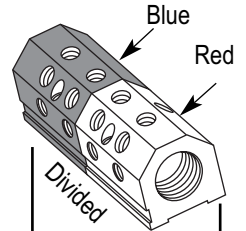

IM8-12-ABC-6-6
1/2 or 3/4
\$228.00

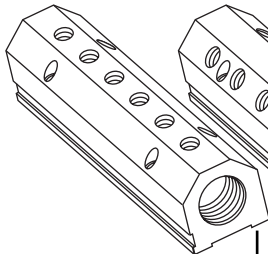
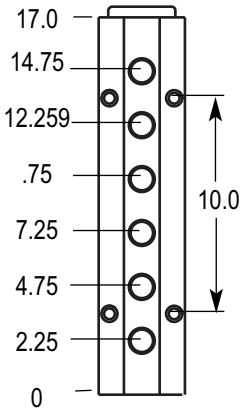

IM8-17-C-6
1/2, 3/4 or 1
\$206.00

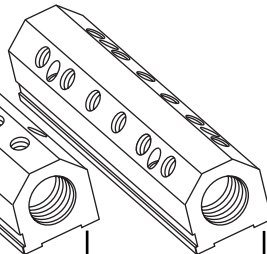

IM8-17-BD-12
1/2, 3/4 or 1
\$242.00

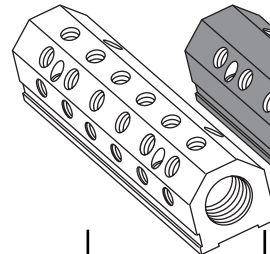

IM8-17-ABC-18
1/2 or 3/4
\$278.00

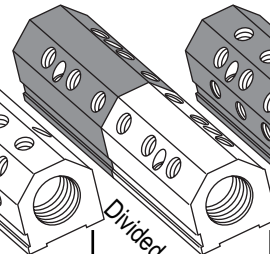

IM8-17-BD-6-6
1/2, 3/4 or 1
\$268.00

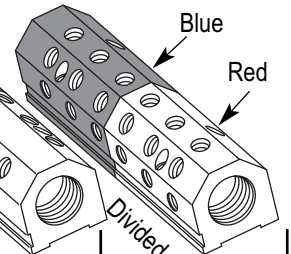

IM8-17-ABC-9-9
1/2 or 3/4
\$304.00

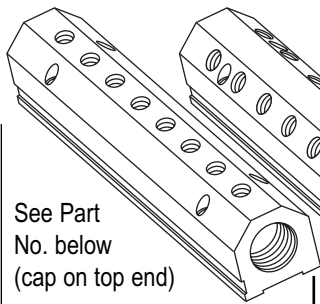
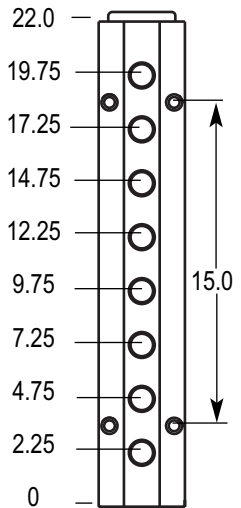

See Part No. below (cap on top end)

IM8-22-C-8
1/2, 3/4 or 1
\$258.00

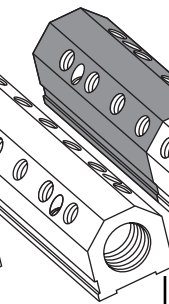

IM8-22-BD-16
1/2, 3/4 or 1
\$306.00

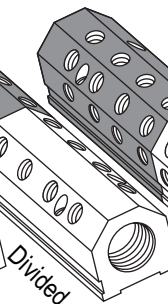

IM8-22-BD-8-8
1/2, 3/4 or 1
\$332.00

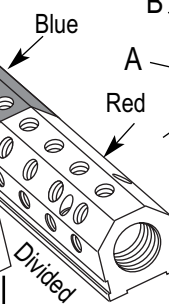

IM8-22-ABC-12-12
1/2 or 3/4
\$380.00

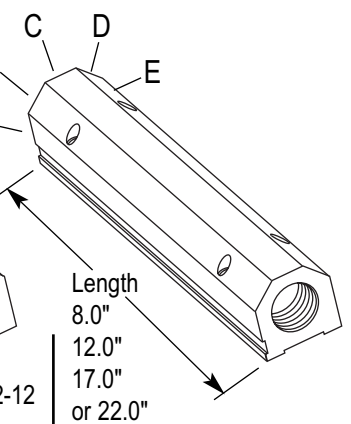

PART NUMBER CODE:

IM8-17-C-6-1/2-N-BLUE

Red, Blue or Divided
Thread Type: N=(NPT) No Marking
P=Mark BSPP
T=Mark BSPT

6 Holes
Row on side "C"
17=17" Overall Length
2" Port (8"=8"x1/4"=2")

Inline Manifold

2" NPT

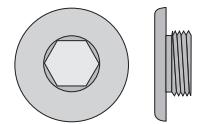

For Solid Color Manifolds
PRICES INCLUDE: End Cap and
Stainless 1/4 - 20 x 3" SHCS.
ADDITIONAL 2" MANIFOLD END
CAPS: IM-8680 - \$16.00ea.
**CUSTOM MANIFOLDS
QUOTED UPON REQUEST**

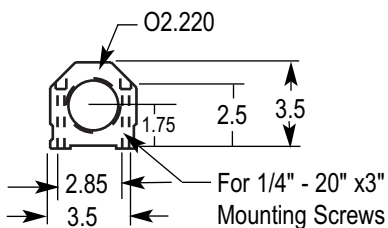

The anodized aluminum is not suitable for corrosive liquids (high chlorine content)

3/4" x 5" Sideline™ Manifold

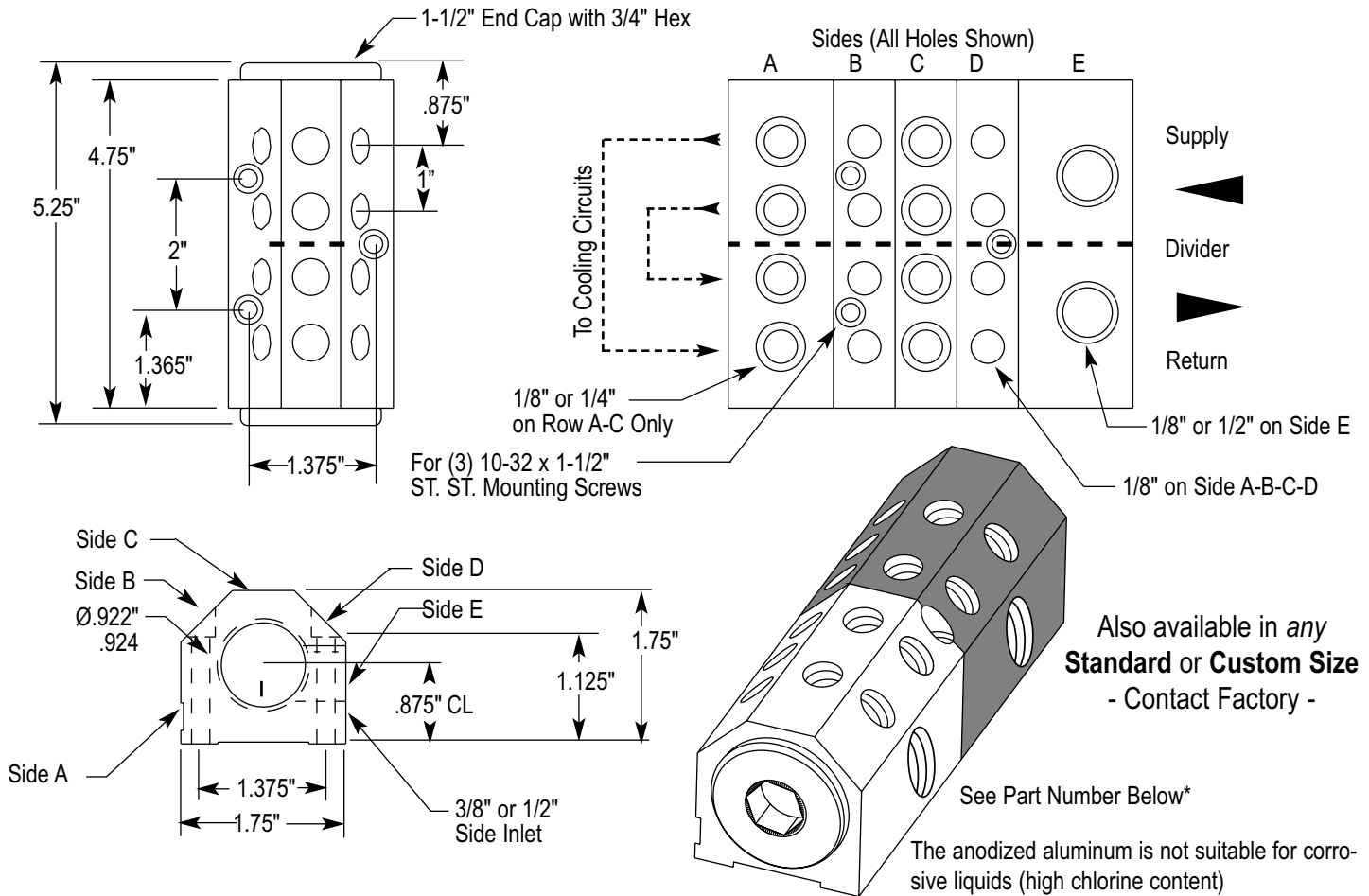

Outgoing Ports					Part Number	Price
Side A In/Out	Side B In/Out	Side C In/Out	Side D In/Out	Side E - Return In/Out		
	(2) (2) 1/8"-1/8"			3/8"-3/8"	IM3S-5-3/8-B-2-2-1/8-N-R/B	\$87.00
(2) (2) 1/8"-1/8"	(2) (2) 1/8"-1/8"			3/8"-3/8"	IM3S-5-3/8-AB-4-4-1/8-N-R/B	\$99.00
	(2) (2) 1/8"-1/8"		(2) (2) 1/8"-1/8"	3/8"-3/8"	*IM3S-5-3/8-BD-4-4-1/8-N-R/B	\$99.00
	(2) (2) 1/8"-1/8"	(2) (2) 1/8"-1/8"	(2) (2) 1/8"-1/8"	3/8"-3/8"	IM3S-5-3/8-BCD-6-6-1/8-N-R/B	\$111.00
(2) (2) 1/8"-1/8"	(2) (2) 1/8"-1/8"	(2) (2) 1/8"-1/8"	(2) (2) 1/8"-1/8"	3/8"-3/8"	IM3S-5-3/8-ABCD-8-8-1/8-N-R/B	\$123.00
	(2) (2) 1/4"-1/4"			1/2"-1/2"	IM3S-5-1/2-B-2-2-1/4-N-R/B	\$87.00
	(2) (2) 1/4"-1/4"		(2) (2) 1/4"-1/4"	1/2"-1/2"	IM3S-5-1/2-BD-4-4-1/4-N-R/B	\$99.00

PRICE INCLUDES: End Caps and (3) 10-32 x 1-1/2" ST. ST. Mtg. Screws. ADDITIONAL 3/4" End Caps \$5.80 ea.

*Part Number Code:

IM3S - 5 - 3/8 - BD - 4 - 4 - 1/8 - N - R/B

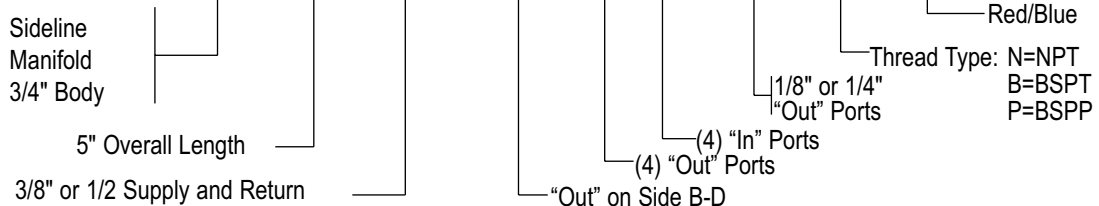

1" x 7" Sideline™ Manifold

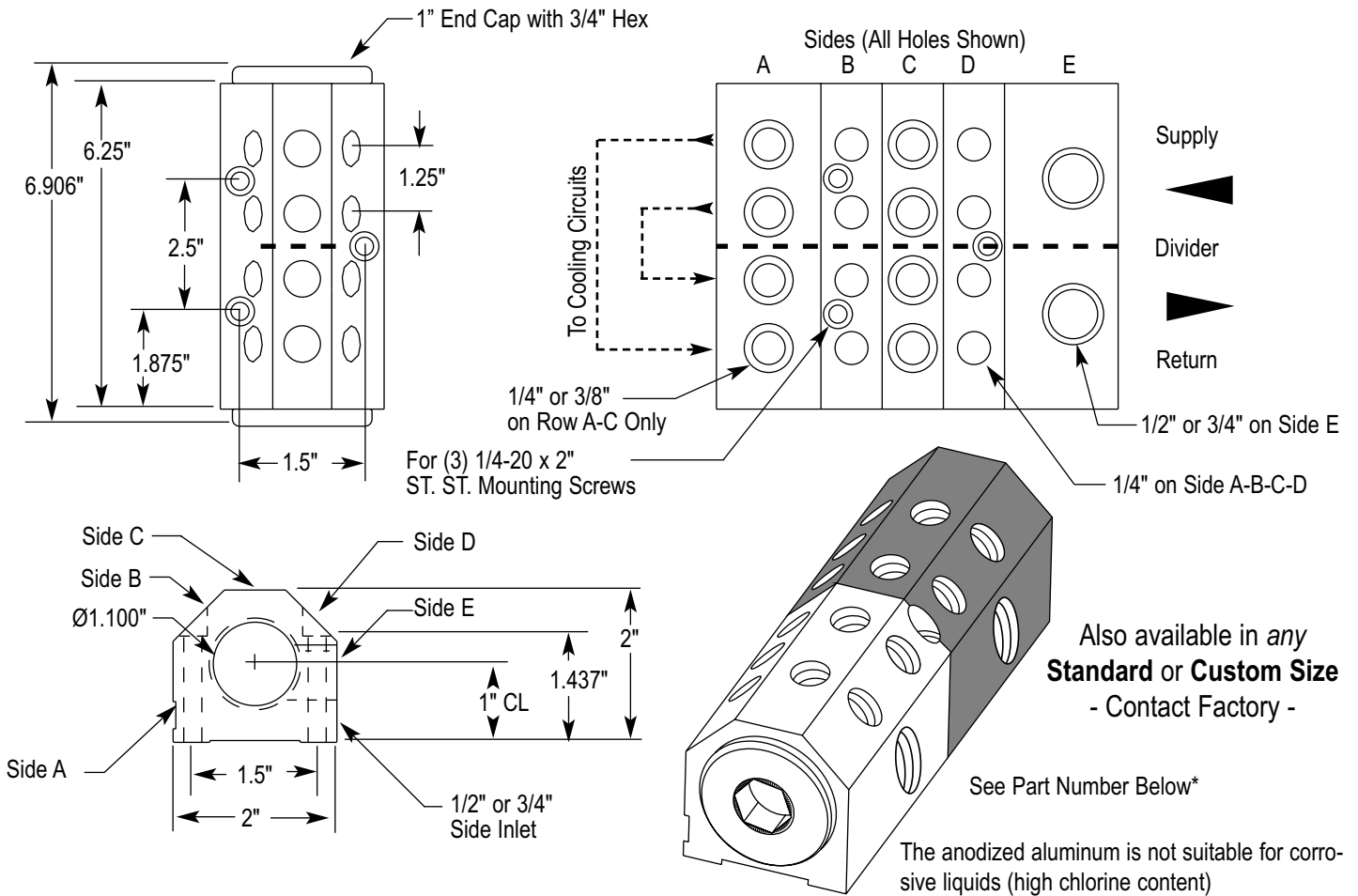

Outgoing Ports					Part Number	Price
Side A In/Out	Side B In/Out	Side C In/Out	Side D In/Out	Side E - Return In/Out		
	(2) (2) 1/4"-1/4"			1/2"-1/2"	IM4S-7-1/2-B-2-2-1/4-N-R/B	\$113.00
(2) (2) 1/4"-1/4"	(2) (2) 1/4"-1/4"			1/2"-1/2"	IM4S-7-1/2-AB-4-4-1/4-N-R/B	\$125.00
	(2) (2) 1/4"-1/4"		(2) (2) 1/4"-1/4"	1/2"-1/2"	IM4S-7-1/2-BD-4-4-1/4-N-R/B	\$125.00
	(2) (2) 1/4"-1/4"	(2) (2) 1/4"-1/4"	(2) (2) 1/4"-1/4"	1/2"-1/2"	*IM4S-7-1/2-BCD-6-6-1/4-N-R/B	\$137.00
(2) (2) 1/4"-1/4"	(2) (2) 1/4"-1/4"	(2) (2) 1/4"-1/4"	(2) (2) 1/4"-1/4"	1/2"-1/2"	IM4S-7-1/2-ABCD-8-8-1/4-N-R/B	\$149.00
	(2) (2) 3/8"-3/8"			3/4"-3/4"	IM4S-7-3/4-B-2-2-3/8-N-R/B	\$113.00
	(2) (2) 3/8"-3/8"		(2) (2) 3/8"-3/8"	3/4"-3/4"	IM4S-7-3/4-BD-4-4-3/8-N-R/B	\$125.00

PRICE INCLUDES: End Caps and (3) 1/4-20x2" ST. ST. Mtg. Screws. ADDITIONAL 1" End Caps \$7.80 ea.

*Part Number Code:

IM4S-7-1/2-BCD-6-6-1/4-N-R/B

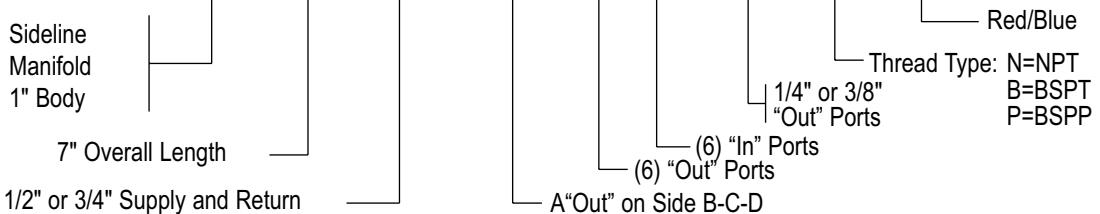

1-1/2" x 10" Sideline™ Manifold

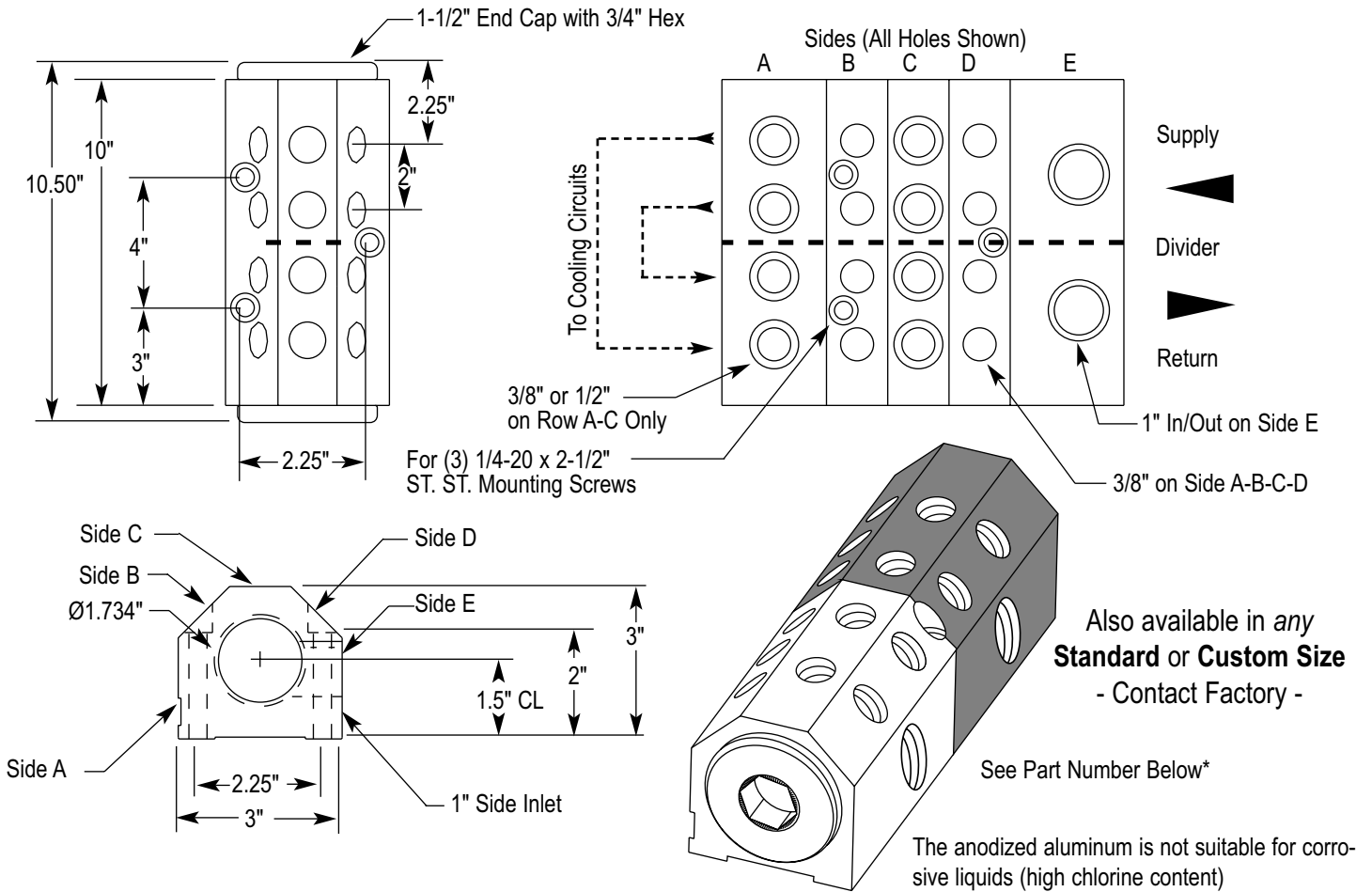

Outgoing Ports					Part Number	Price
Side A In/Out	Side B In/Out	Side C In/Out	Side D In/Out	Side E - Return In/Out		
	(2) (2) 3/8"-3/8"			1"-1"	IM6S-10-1-B-2-2-3/8-N-R/B	\$159.00
(2) (2) 3/8"-3/8"	(2) (2) 3/8"-3/8"			1"-1"	IM6S-10-1-AB-4-4-3/8-N-R/B	\$175.00
	(2) (2) 3/8"-3/8"		(2) (2) 3/8"-3/8"	1"-1"	IM6S-10-1-BD-4-4-3/8-N-R/B	\$175.00
	(2) (2) 3/8"-3/8"	(2) (2) 3/8"-3/8"	(2) (2) 3/8"-3/8"	1"-1"	IM6S-10-1-ABC-6-6-3/8-N-R/B	\$191.00
(2) (2) 3/8"-3/8"	(2) (2) 3/8"-3/8"	(2) (2) 3/8"-3/8"	(2) (2) 3/8"-3/8"	1"-1"	*IM6S-10-1-ABCD-8-8-3/8-N-R/B	\$207.00
	(2) (2) 1/2"-1/2"			1"-1"	IM6S-10-1-B-2-2-1/2-N-R/B	\$159.00
	(2) (2) 1/2"-1/2"		(2) (2) 1/2"-1/2"	1"-1"	IM6S-10-1-BD-4-4-1/2-N-R/B	\$175.00

PRICE INCLUDES: End Caps and (3) 1/4-20 x 2-1/2" ST. ST. Mtg. Screws. ADDITIONAL 1-1/2" End Caps \$14.00 ea.

*Part Number Code:

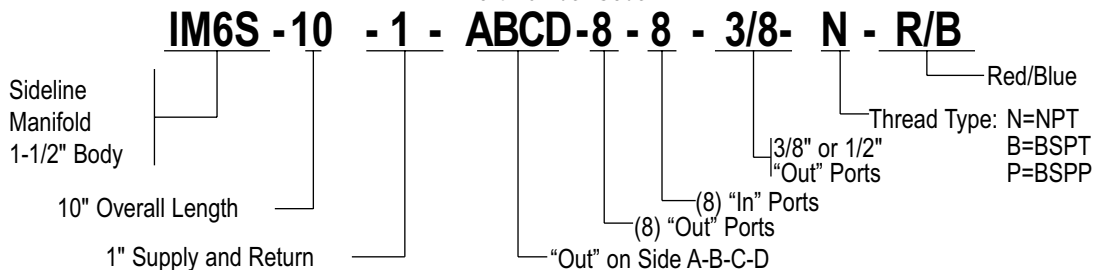

2" x 12" Sideline™ Manifold

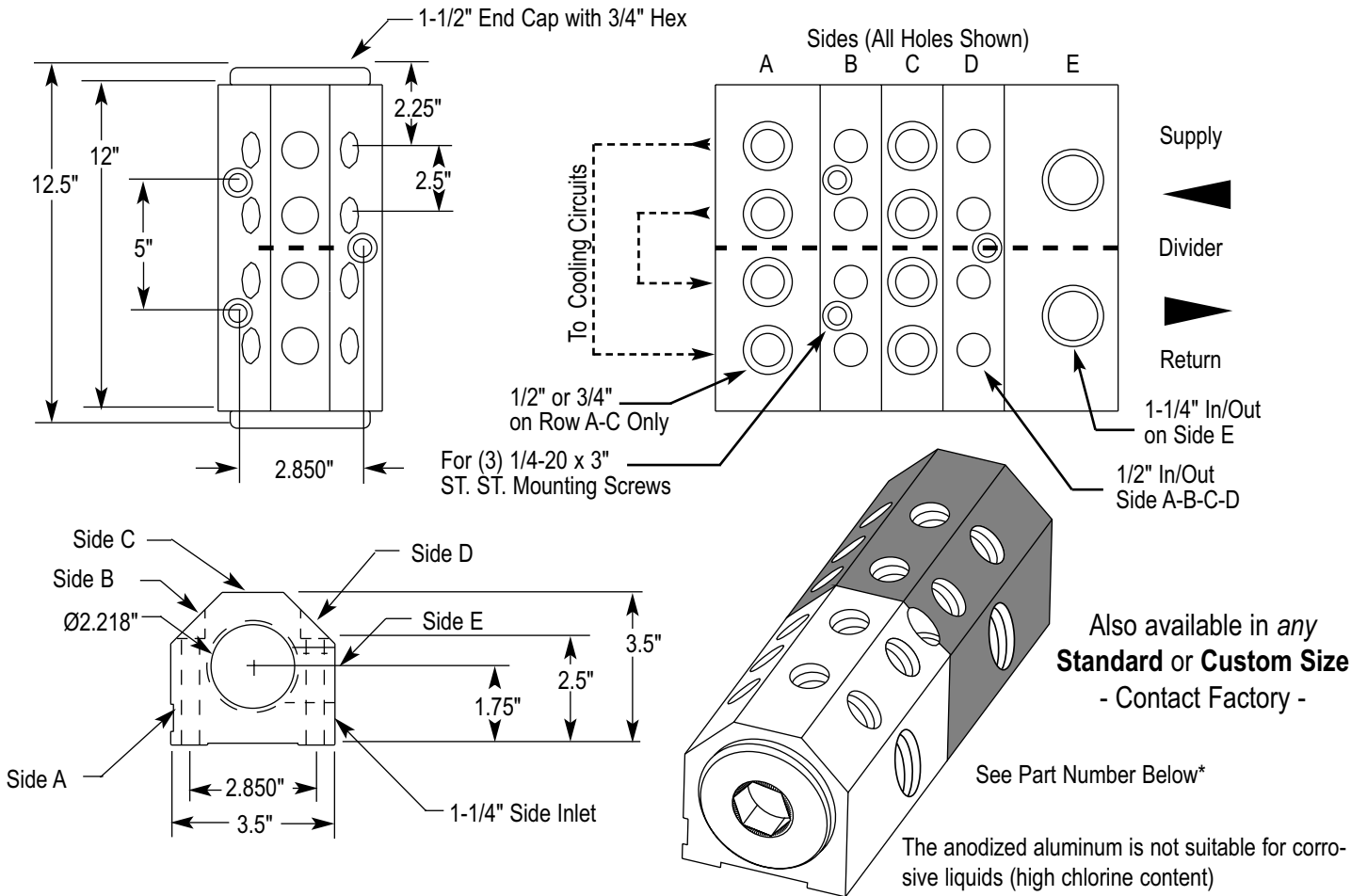

Outgoing Ports					Part Number	Price
Side A In/Out	Side B In/Out	Side C In/Out	Side D In/Out	Side E - Return In/Out		
	(2) (2) 1/2"-1/2"			1-1/4"-1-1/4"	IM8S-12-1-1/4-B-2-2-1/2-N-R/B	\$220.00
(2) (2) 1/2"-1/2"	(2) (2) 1/2"-1/2"			1-1/4"-1-1/4"	IM8S-12-1-1/4-AB-4-4-1/2-N-R/B	\$244.00
	(2) (2) 1/2"-1/2"		(2) (2) 1/2"-1/2"	1-1/4"-1-1/4"	IM8S-12-1-1/4-BD-4-4-1/2-N-R/B	\$244.00
	(2) (2) 1/2"-1/2"	(2) (2) 1/2"-1/2"	(2) (2) 1/2"-1/2"	1-1/4"-1-1/4"	IM8S-12-1-1/4-BCD-6-6-1/2-N-R/B	\$268.00
(2) (2) 1/2"-1/2"	(2) (2) 1/2"-1/2"	(2) (2) 1/2"-1/2"	(2) (2) 1/2"-1/2"	1-1/4"-1-1/4"	*IM8S-12-1-1/4-ABCD-8-8-1/2-N-R/B	\$292.00
	(2) (2) 3/4"-3/4"			1-1/4"-1-1/4"	IM8S-12-1-1/4-B-2-2-3/4-N-R/B	\$220.00
	(2) (2) 3/4"-3/4"		(2) (2) 3/4"-3/4"	1-1/4"-1-1/4"	IM8S-12-1-1/4-BD-4-4-3/4-N-R/B	\$244.00

PRICE INCLUDES: End Caps and 1/4 - 20 x 3" ST. ST. Mtg. Screws. ADDITIONAL 2" End Caps \$16.00 ea.

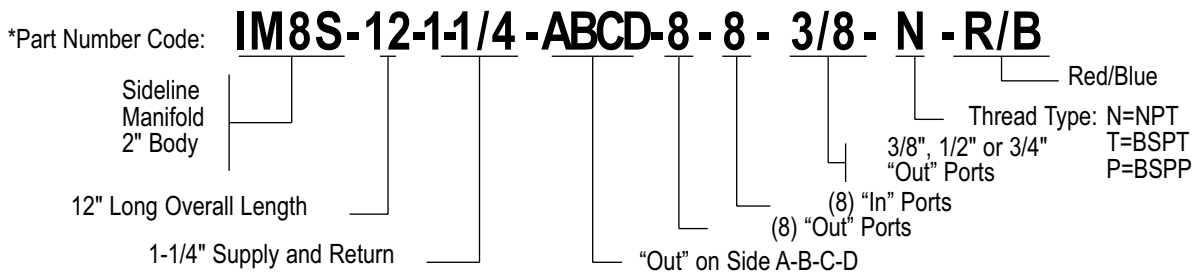

BottomLine™ Custom Mold Mounted Manifold

3/4" IM3

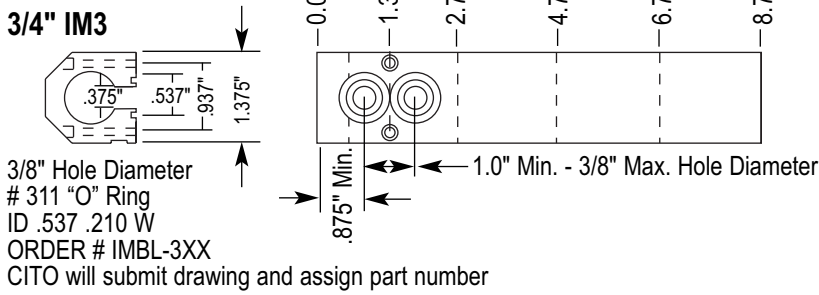

1" IM4

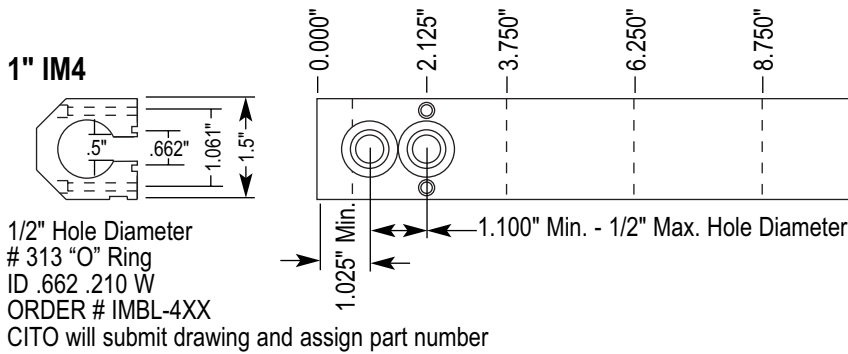

1-1/2" IM6

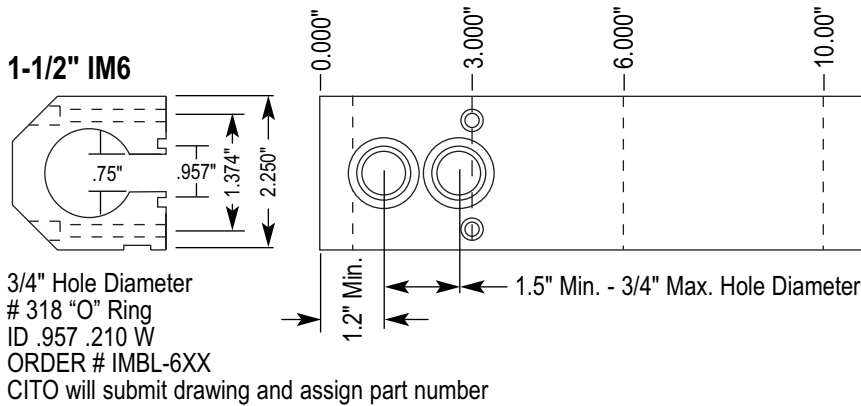

2" IM8

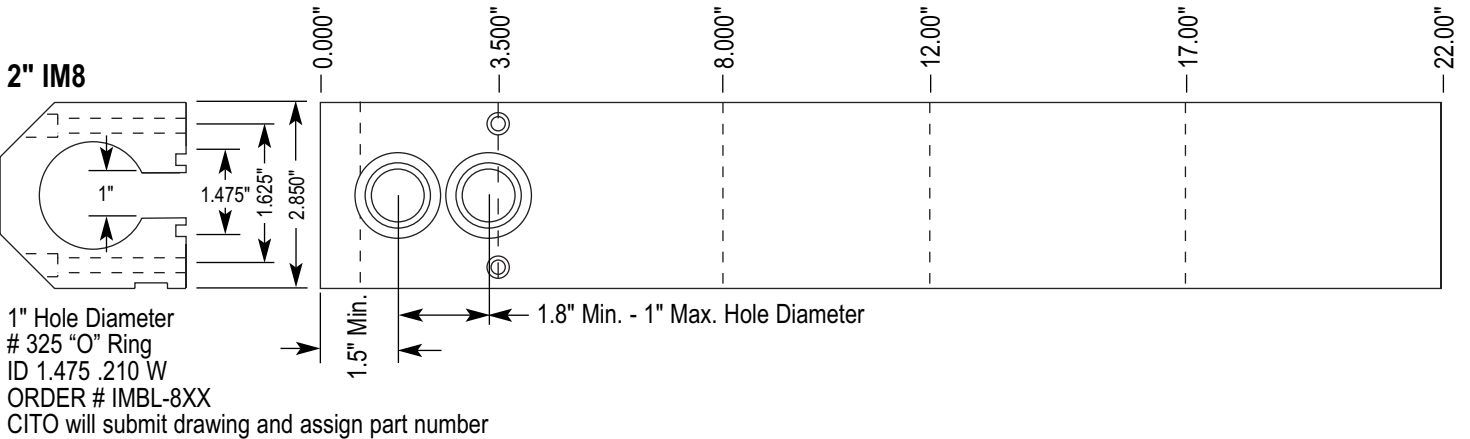

Submit your requirements for pricing and delivery

CITO PRODUCTS INC.
 ATTENTION: SALES DEPARTMENT